



## Display Warmers

Models DW-CN-0065, 0085, 0102, 0121, 0138  
Items 47510, 43465, 47511, 47512, 47513

## Instruction Manual



*Revised - 08/26/2022*

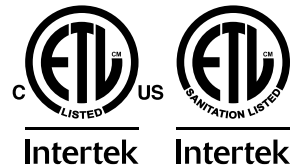

Toll Free: 1-800-465-0234  
Fax: 905-607-0234  
Email: [service@omcan.com](mailto:service@omcan.com)  
[www.omcan.com](http://www.omcan.com)

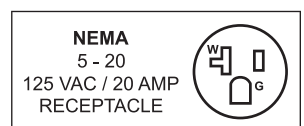

# ***Table of Contents***

Model DW-CN-0065 / Model DW-CN-0085 / Model DW-CN-0102  
Model DW-CN-0121 / Model DW-CN-0138

---

<b>Section</b>	<b>Page</b>
General Information -----	3 - 4
Safety and Warranty -----	4 - 6
Technical Specifications -----	6
Installation -----	6
Operation -----	6 - 7
Maintenance -----	7
Parts Breakdown -----	8 - 17
Electrical Schematics -----	18
Warranty Registration -----	19



# General Information

---

Omcan Manufacturing and Distributing Company Inc., Food Machinery of America, Inc. dba Omcan and Omcan Inc. are not responsible for any harm or injury caused due to any person's improper or negligent use of this equipment. The product shall only be operated by someone over the age of 18, of sound mind, and not under the influence of any drugs or alcohol, who has been trained in the correct operation of this machine, and is wearing authorized, proper safety clothing. Any modification to the machine voids any warranty, and may cause harm to individuals using the machine or in the vicinity of the machine while in operation.

## CHECK PACKAGE UPON ARRIVAL

Upon receipt of an Omcan shipment please inspect for external damage. If no damage is evident on the external packaging, open carton to ensure all ordered items are within the box, and there is no concealed damage to the machine. If the package has suffered rough handling, bumps or damage (visible or concealed), please note it on the bill of lading before accepting the delivery and contact Omcan within 24 hours, so we may initiate a claim with the carrier. A detailed report on the extent of the damage caused to the machine must be filled out within three days, from the delivery date shown in the shipping documents. Omcan has no recourse for damaged products that were shipped collect or third party.

**Before operating any equipment, always read and familiarize yourself with all operation and safety instructions.**

Omcan would like to thank you for purchasing this machine. It's of the utmost importance to save these instructions for future reference. Also save the original box and packaging for shipping the equipment if servicing or returning of the machine is required.

---

Omcan Fabrication et distribution Compañie Limité et Food Machinery d'Amérique, dba Omcan et Omcan Inc. ne sont pas responsables de tout dommage ou blessure causé du fait que toute personne ait utilisé cet équipement de façon irrégulière. Le produit ne doit être exploité que par quelqu'un de plus de 18 ans, saine d'esprit, et pas sous l'influence d'une drogue ou d'alcool, qui a été formé pour utiliser cette machine correctement, et est vêtu de vêtements de sécurité approprié. Toute modification de la machine annule toute garantie, et peut causer un préjudice à des personnes utilisant la machine ou des personnes à proximité de la machine pendant son fonctionnement.

## VÉRIFIEZ LE COLIS DÈS RÉCEPTION

Dès réception d'une expédition d'Omcan veuillez inspecter pour dommages externes. Si aucun dommage n'est visible sur l'emballage externe, ouvrez le carton afin de s'assurer que tous les éléments commandés sont dans la boîte, et il n'y a aucun dommage dissimulé à la machine. Si le colis n'a subi aucune mauvaises manipulations, de bosses ou de dommages (visible ou cachée), notez-le sur le bond de livraison avant d'accepter la livraison et contactez Omcan dans les 24 heures qui suivent, pour que nous puissions engager une réclamation auprès du transporteur. Un rapport détaillé sur l'étendue des dommages causés à la machine doit être rempli dans un délai de trois jours, à compter de la date de livraison indiquée dans les documents d'expédition. Omcan n'a aucun droit de recours pour les produits endommagés qui ont été expédiés ou cueilli par un tiers transporteur.

# General Information

---

Avant d'utiliser n'importe quel équipement, toujours lire et vous familiariser avec toutes les opérations et les consignes de sécurité.

Omcan voudrais vous remercier d'avoir choisi cette machine. Il est primordial de conserver ces instructions pour une référence ultérieure. Également conservez la boîte originale et l'emballage pour l'expédition de l'équipement si l'entretien ou le retour de la machine est nécessaire.

---

Omcan Empresa De Fabricacion Y Distribucion Inc. Y Maquinaria De Alimentos De America, Inc. dba Omcan y Omcan Inc. no son responsables de ningun daño o perjuicio causado por cualquier persona inadecuada o el uso descuidado de este equipo. El producto solo podra ser operado por una persona mayor de 18 años, en su sano juicio y no bajo alguna influencia de droga o alcohol, y que este ha sido entrenado en el correcto funcionamiento de esta máquina, y ésta usando ropa apropiada y autorizada. Cualquier modificación a la máquina anula la garantía y puede causar daños a las personas usando la máquina mientras esta en el funcionamiento.

## REVISE EL PAQUETE A SU LLEGADA

Tras la recepcion de un envio Omcan favor inspeccionar daños externos. Si no hay daños evidentes en el empaque exterior, Habra el carton para asegurarse que todos los articulos solicitados estén dentro de la caja y no encuentre daños ocultos en la máquina. Si el paquete ha sufrido un manejo de poco cuidado, golpes o daños (visible o oculto) por favor anote en la factura antes de aceptar la entrega y contacte Omcan dentro de las 24 horas, de modo que podamos iniciar una reclamación con la compañía. Un informe detallado sobre los daños causados a la máquina debe ser llenado en el plazo de tres días, desde la fecha de entrega que se muestra en los documentos de envío. Omcan no tiene ningun recurso por productos dañados que se enviaron a recoger por terceros.

Antes de utilizar cualquier equipo, siempre lea y familiarizarse con todas las instrucciones de funcionamiento y seguridad.

Omcan le gustaría darle las gracias por la compra de esta máquina. Es de la mayor importancia para salvar estas instrucciones para futuras consultas. Además, guarda la caja original y el embalaje para el envío del equipo si servicio técnico o devolución de la máquina que se requiere.

# Safety and Warranty

---

- To prevent hazards and to ensure optimum efficiency, no modifications or alterations to the device that are not explicitly approved by the manufacturer may be undertaken.  
This device may only be operated in technically proper and safe conditions.
- The device should never be left unattended during operation. Keep away from children.
- Keep this manual in a safe and easily accessible location. When passing on/selling the device to a third party, the manual must be handed over along with the device.
- Every person using the device must read the manual in its entirety and must follow its safety advice.

# Safety and Warranty

---

- The device is to be used indoors only.
- Any technical interventions, as well as assembly and maintenance are to be made by a qualified service technician only.
- This appliance is not intended for use by persons (including children) with reduced physical, sensory or mental capabilities, or lack of experience and knowledge, unless they have been given supervision or instruction concerning use of the appliance by a person responsible for their safety.
- Children should be supervised to ensure that they do not play with the appliance.

## **Exclusive power socket**

The power receptacle must have a reliable grounded connection.

## **Not to be on a shared socket**

Never let the device share the common socket with other appliance, otherwise the cable becomes hot and fire might be resulted.

## **Protect cables**

Never break or damage the cables otherwise current leakage and fire might be resulted.

## **Do not spray with water**

Never spray the surface of the device with water otherwise current leakage might be resulted.

## **Keep away from flammables and explosives**

Never put any flammable or explosives inside or near the device such as ether, gasoline, alcohol, adhesive and explosives.

**RESIDENTIAL USERS: Vendor assumes no liability for parts or labor coverage for component failure or other damages resulting from installation in non-commercial or residential applications. The right is reserved to deny shipment for residential usage; if this occurs, you will be notified as soon as possible.**

## **1 YEAR PARTS AND LABOUR BENCH WARRANTY**

Within the warranty period, contact Omcan Inc. at 1-800-465-0234 to schedule a drop off to either an Omcan authorized service depot in the area, or to an Omcan Service warehouse to repair the equipment.

Unauthorized maintenance will void the warranty. Warranty covers electrical and part failures, not improper use.

Please see <https://omcan.com/disclaimer> for complete info.

## **WARNING:**

The packaging components are classified as normal solid urban waste and can therefore be disposed of without difficulty.

# Safety and Warranty

In any case, for suitable recycling, we suggest disposing of the products separately (differentiated waste) according to the current norms.

**DO NOT DISCARD ANY PACKAGING MATERIALS IN THE ENVIRONMENT!**

# Technical Specifications

Model	DW-CN-0065	DW-CN-0085	DW-CN-0102	DW-CN-0121	DW-CN-0138
Temperature Range	30 - 90°C / 86 - 194°F				
Power	1800W				
Electrical	120V / 60Hz / 1				
Current	15A				
Display Area	0.65m <sup>2</sup>	0.85m <sup>2</sup>	1.02m <sup>2</sup>	1.21m <sup>2</sup>	1.38m <sup>2</sup>
Weight	72.8 lbs. / 33 kgs.	90.4 lbs. / 41 kgs.	108 lbs. / 49 kgs.	121.3 lbs. / 55 kgs.	143.3 lbs. / 65 kgs.
Dimensions	23.6" x 27.8" x 27.2" 600 x 707 x 691mm	31.5" x 27.8" x 27.2" 800 x 707 x 691mm	37.5" x 27.8" x 27.2" 953 x 707 x 691mm	43.5" x 27.8" x 27.2" 1106 x 707 x 691mm	49.6" x 27.8" x 27.2" 1259 x 707 x 691mm
Packaging Dimensions	26.2" x 30.2" x 29" 666 x 767 x 736mm	34.1" x 30.2" x 29" 866 x 767 x 736mm	40.1" x 30.2" x 29" 1019 x 767 x 736mm	46.1" x 30.2" x 29" 1172 x 767 x 736mm	52.2" x 30.2" x 29" 1325 x 767 x 736mm
Item Number	47510	43465	47511	47512	47513

# Installation

- Place the device on top of an even and safe surface which supports the weight of the device and is not heat sensitive.
- Not at any time should you place the device on an inflammable surface (such as table cloth, carpet, etc).
- You must not position the device near open fireplaces, electric ovens/arc furnaces/electric heaters or other heat sources.
- Position the device in such a way that the plug is easily accessible.

# Operation

- Before first use, clean the inner sides and the playing grids with a soft cloth and a mild cleaning agent. Afterwards, dry the device thoroughly.
- Remove the water bowl from the device. The water bowl is installed inside the device and then fill the water bowl with water.

# Operation

---

- Connect the device to a single grounded power socket.
- Set the temperature as required for respective foods. You may adjust the desired temperature in the range between 30°C-90°C.
- The temperature inside of the hot display can be read from the front display.
- Put the foods in appropriate containers before playing them inside the hot display and shut is by using the sliding door.
- Some of the device parts become very hot, always use safety gloves when placing or removing foods.
- The foods are kept warm at the temperature set by you previously.
- In order to place or remove foods. You may open the door at rear side.
- Switch on the inner light when required using the light switch of the device.
- Disconnect the device from the power socket when the device is not in use.

# Maintenance

---

- Before beginning with repair or cleaning works make sure the device has been disconnected from the power socket and has cooled down.
- Don't use any acid agents and make sure no water ingresses the device.
- To protect yourself from the electric shock, never immerse the device, its cables and the plug in water or other liquids.
- Don't use any kind of pressure water jet for cleaning the device.

## CLEANING

- The device should be cleaned regularly.
- Clean the device from the inside and outside with a soft, damp cloth and a mild cleaning agent.
- Clean the placing grids and the housing with a soft, damp cloth and a mild cleaning agent.
- Clean the water bowl regularly. Calcifications at the water bowl may be removed with common agents or liquids.
- Only use a soft cloth and make sure you never use any kind of abrasive agents or pads which could scratch the surface.
- After the cleaning procedure, you should use a soft and dry cloth to wipe dry and polish the surface.
- Make sure the device has been cleaned properly before storing it in a dry place.

## MAINTENANCE

- Check the mains lead from time to time to ensure it is not damaged in any way. Never use the device if the lead is damaged. If the lead is damaged, it must be replaced by a qualified electrician.
- Only a qualified technician should carry out repairs and maintenance of the device, Do not attempt to repair the device by yourself.

## CAUTIONS

Children should be supervised to ensure that they do not play with the appliance.

- If the supply cord is damaged, it must be replaced by the manufacturer, its service agent or similarly qualified persons in order to avoid a hazard.

# Parts Breakdown

Model DW-CN-0065 47510

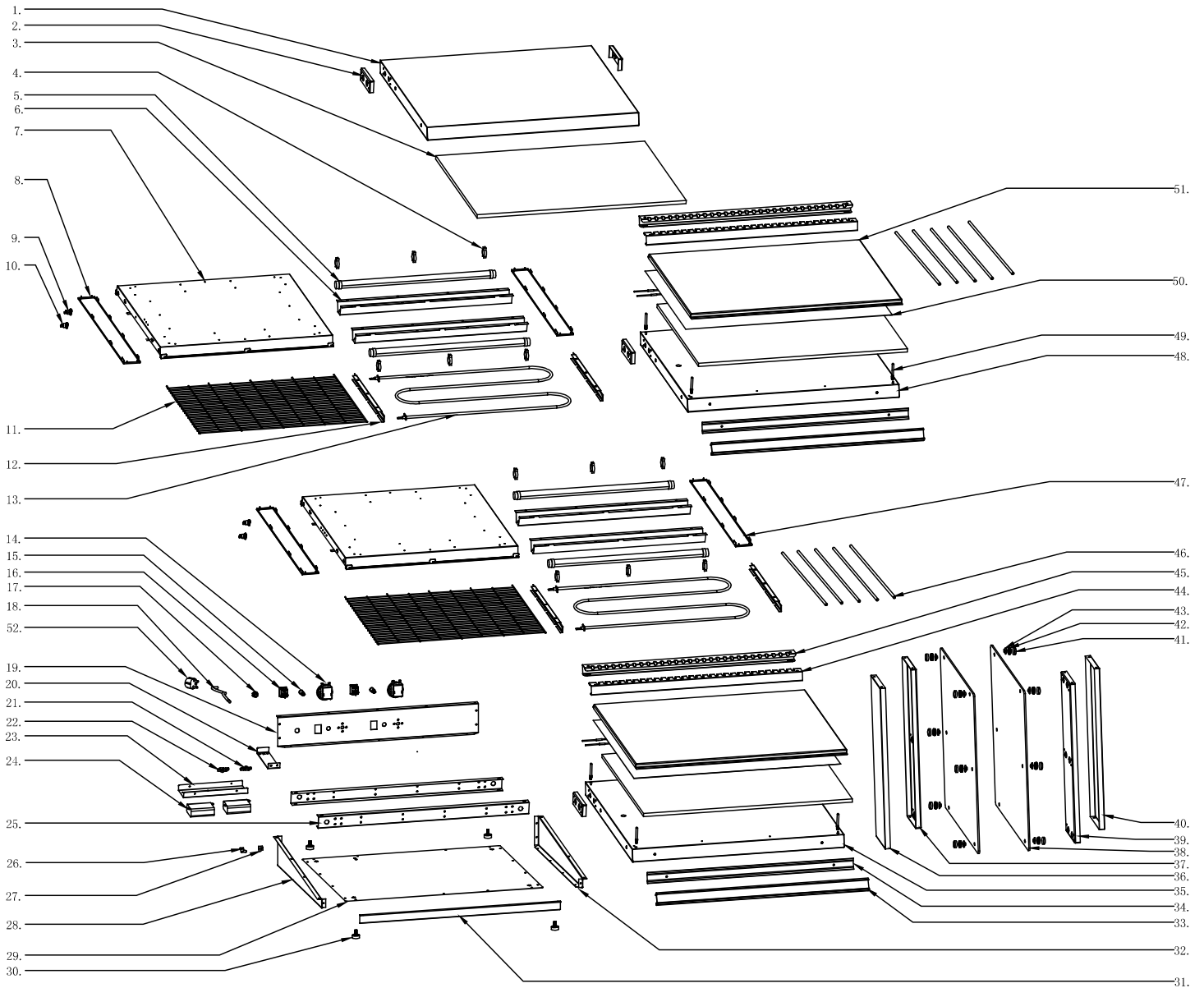





# Parts Breakdown

## Model DW-CN-0065 47510

Item No.	Description	Position	Item No.	Description	Position	Item No.	Description	Position
AL018	Top Outer Frame for 47510	1	AK996	Back Frame for 47510	19	AL008	Left Inner Pole for 47510	37
60492	Inner Reinforcing Plate for 47510	2	AK997	Cable Clip Fixer for 47510	20	60487	Side Glass for 47510	38
AK986	Insulation for 47510	3	61246	Wire Clip Holder for 47510	21	AL009	Right Inner Pole for 47510	39
AL078	Light Supporting Bar for 47510	4	61245	Wire Clip Cover for 47510	22	AL010	Right Outer Pole for 47510	40
AK988	LED for 47510	5	AK998	LED Power Supporting Bar for 47510	23	60101	Decorating Gasket of Nut for 47510	41
AK989	Light Guard for 47510	6	AK999	LED Power for 47510	24	60102	Nut Decorating Parts for 47510	42
AK990	Heating Tube Supporting Bar for 47510	7	AL000	Inner Supporting Bar for 47510	25	60103	Big Gasket of Nut for 47510	43
AK991	Left Guard for 47510	8	AD870	Fixed Plate for 47510	26	AL011	Supporting Bar of Front Shelf for 47510	44
70862	Thermostat T1/33 for 47510	9	AD869	Steel Ingot for 47510	27	AL012	Supporting Bar of Back Shelf for 47510	45
70863	Thermostat T1M/33 for 47510	10	60488	Left Frame for 47510	28	AL013	Bar for 47510	46
AK992	Protect Nets for 47510	11	AL001	Baseboard for 47510	29	AL014	Right Guard for 47510	47
AK993	Heating Element Frame for 47510	12	AL002	Rubber Feet for 47510	30	AL015	Middle Outer Frame for 47510	48
AK994	Heating Element for 47510	13	AL003	Front Frame for 47510	31	60479	Bolt for 47510	49
71640	Temperature Thermostat for 47510	14	60514	Right Frame for 47510	32	AL016	Aluminum Foil Heater for 47510	50
60218	Indicator Light for 47510	15	AL004	Price Tag for 47510	33	AL017	Cover Plate for 47510	51
70688	Switch for 47510	16	AL005	Price Tag Guard for 47510	34	AL096	Plug 5-20P for 47510	52
60213	Double-Faced Protective Ring C12 for 47510	17	AL006	Bottom Outer Frame for 47510	35			
AK995	Power Line for 47510	18	AL007	Left Outer Pole for 47510	36			

# Parts Breakdown

Model DW-CN-0085 43465

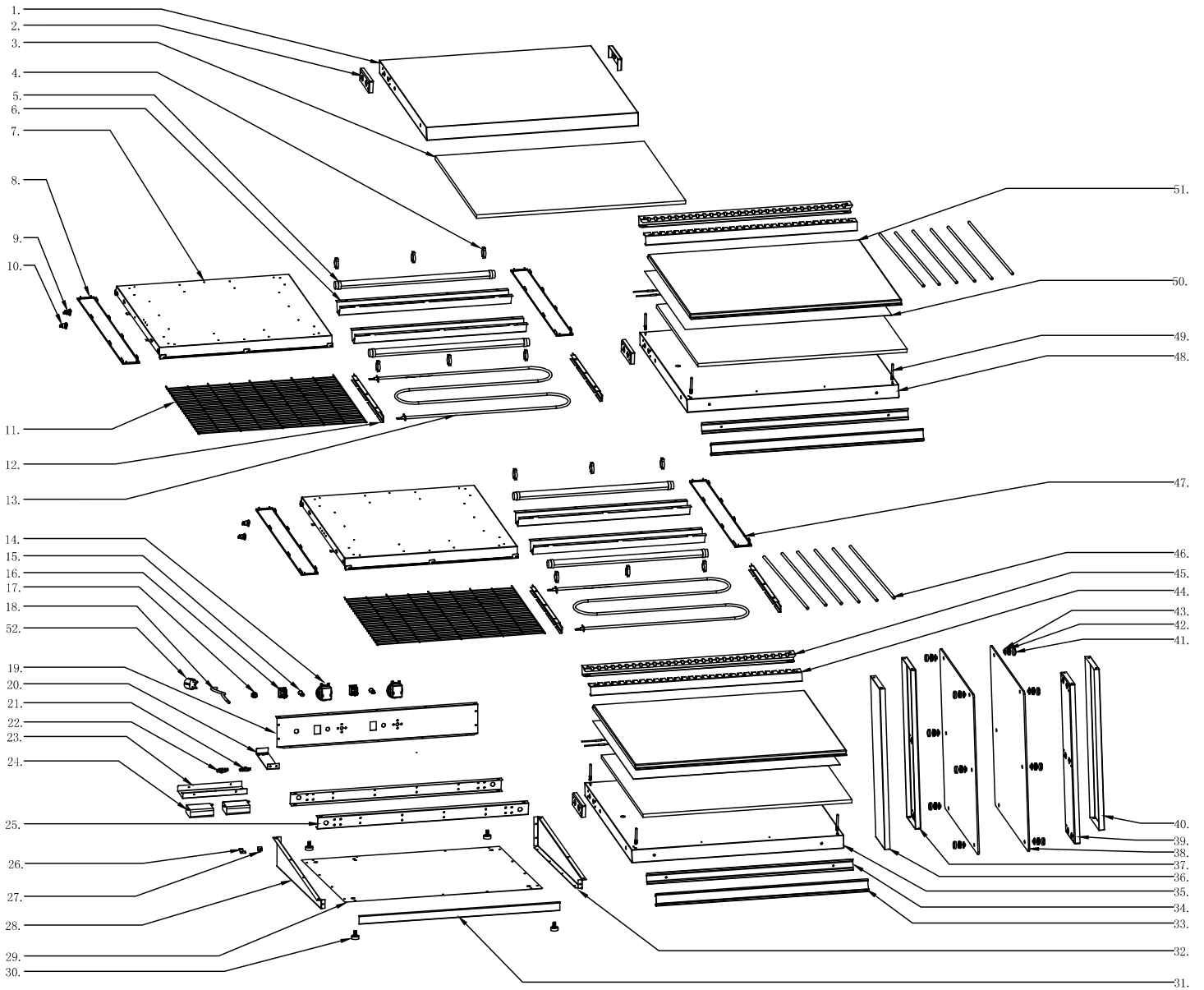



# Parts Breakdown

## Model DW-CN-0085 43465

Item No.	Description	Position	Item No.	Description	Position	Item No.	Description	Position
AL076	Top Outer Frame for 43465	1	AK995	Power Line for 43465	18	AL007	Left Outer Pole for 43465	36
60492	Inner Reinforcing Plate for 43465	2	AL085	Back Frame for 43465	19	AL008	Left Inner Pole for 43465	37
AL077	Insulation for 43465	3	60514	Right Frame for 43465	20, 32	60487	Side Glass for 43465	38
AL078	Light Supporting Bar for 43465	4	61246	Wire Clip Holder for 43465	21	AL009	Right Inner Pole for 43465	39
AL079	LED for 43465	5	61245	Wire Clip Cover for 43465	22	AL010	Right Outer Pole for 43465	40
AL080	Light Guard for 43465	6	AK998	LED Power Supporting Bar for 43465	23	60101	Decorating Gasket of Nut for 43465	41
AL081	Heating Tube Supporting Bar for 43465	7	AK999	LED Power for 43465	24	60102	Nut Decorating Parts for 43465	42
AK991	Left Guard for 43465	8	AL086	Inner Supporting Bar for 43465	25	60103	Big Gasket of Nut for 43465	43
70862	Thermostat T1/33 for 43465	9	AD870	Fixed Plate for 43465	26	AL091	Supporting Bar of Front Shelf for 43465	44
70863	Thermostat T1M/33 for 43465	10	AD869	Steel Ingot for 43465	27	AL092	Supporting Bar of Back Shelf for 43465	45
AL082	Protect Nets for 43465	11	60488	Left Frame for 43465	28	AL013	Bar for 43465	46
AK993	Heating Element Frame for 43465	12	60489	Baseboard for 43465	29	AL014	Right Guard for 43465	47
AL083	Heating Element for 43465	13	AL002	Rubber Feet for 43465	30	AL093	Middle Outer Frame for 43465	48
71640	Temperature Thermostat for 43465	14	AL087	Front Frame for 43465	31	60479	Bolt for 43465	49
60218	Indicator Light for 43465	15	AL088	Price Tag for 43465	33	AL094	Aluminum Foil Heater for 43465	50
70688	Switch for 43465	16	AL089	Price Tag Guard for 43465	34	AL095	Cover Plate for 43465	51
AL084	Protective Ring for 43465	17	AL090	Bottom Outer Frame for 43465	35	AL096	Plug 5-20P for 43465	52

# Parts Breakdown

Model DW-CN-0102 47511

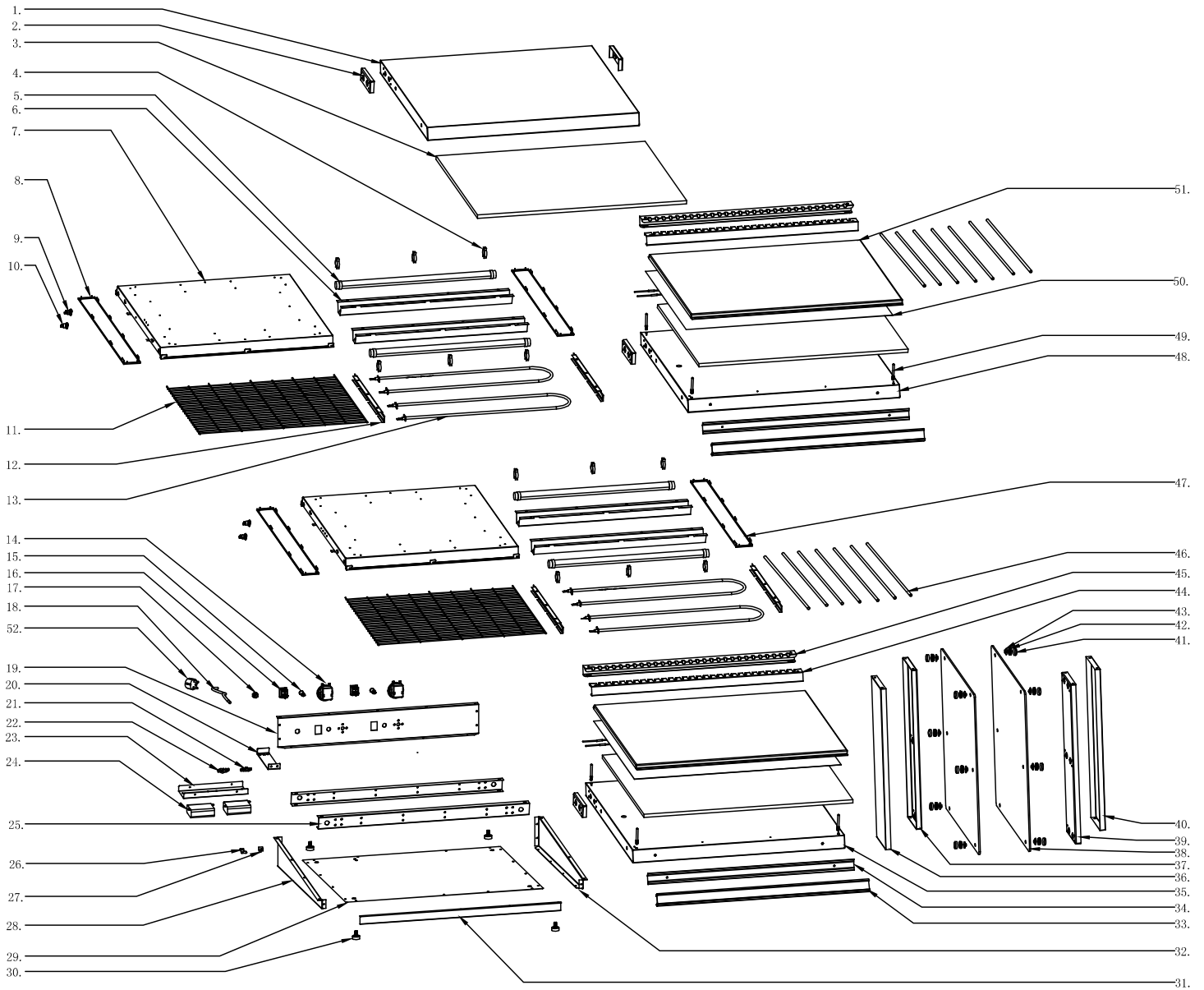



# Parts Breakdown

## Model DW-CN-0102 47511

Item No.	Description	Position	Item No.	Description	Position	Item No.	Description	Position
AL019	Top Outer Frame for 47511	1	AL026	Back Frame for 47511	19	AL008	Left Inner Pole for 47511	37
60492	Inner Reinforcing Plate for 47511	2	AK997	Cable Clip Fixer for 47511	20	60487	Side Glass for 47511	38
AL020	Insulation for 47511	3	61246	Wire Clip Holder for 47511	21	AL009	Right Inner Pole for 47511	39
AL078	Light Supporting Bar for 47511	4	61245	Wire Clip Cover for 47511	22	AL010	Right Outer Pole for 47511	40
AL021	LED for 47511	5	AK998	LED Power Supporting Bar for 47511	23	60101	Decorating Gasket of Nut for 47511	41
AL022	Light Guard for 47511	6	AK999	LED Power for 47511	24	60102	Nut Decorating Parts for 47511	42
AL023	Heating Tube Supporting Bar for 47511	7	AL027	Inner Supporting Bar for 47511	25	60103	Big Gasket of Nut for 47511	43
AK991	Left Guard for 47511	8	AD870	Fixed Plate for 47511	26	AL033	Supporting Bar of Front Shelf for 47511	44
70862	Thermostat T1/33 for 47511	9	AD869	Steel Ingot for 47511	27	AL034	Supporting Bar of Back Shelf for 47511	45
70863	Thermostat T1M/33 for 47511	10	60488	Left Frame for 47511	28	AL013	Bar for 47511	46
AL024	Protect Nets for 47511	11	AL028	Baseboard for 47511	29	AL014	Right Guard for 47511	47
AK993	Heating Element Frame for 47511	12	AL002	Rubber Feet for 47511	30	AL035	Middle Outer Frame for 47511	48
AL025	Heating Element for 47511	13	AL029	Front Frame for 47511	31	60479	Bolt for 47511	49
71640	Temperature Thermostat for 47511	14	60514	Right Frame for 47511	32	AL036	Aluminum Foil Heater for 47511	50
60218	Indicator Light for 47511	15	AL030	Price Tag for 47511	33	AL037	Cover Plate for 47511	51
70688	Switch for 47511	16	AL031	Price Tag Guard for 47511	34	AL096	Plug 5-20P for 47511	52
60213	Double-Faced Protective Ring C12 for 47511	17	AL032	Bottom Outer Frame for 47511	35			
AK995	Power Line for 47511	18	AL007	Left Outer Pole for 47511	36			

# Parts Breakdown

Model DW-CN-0121 47512

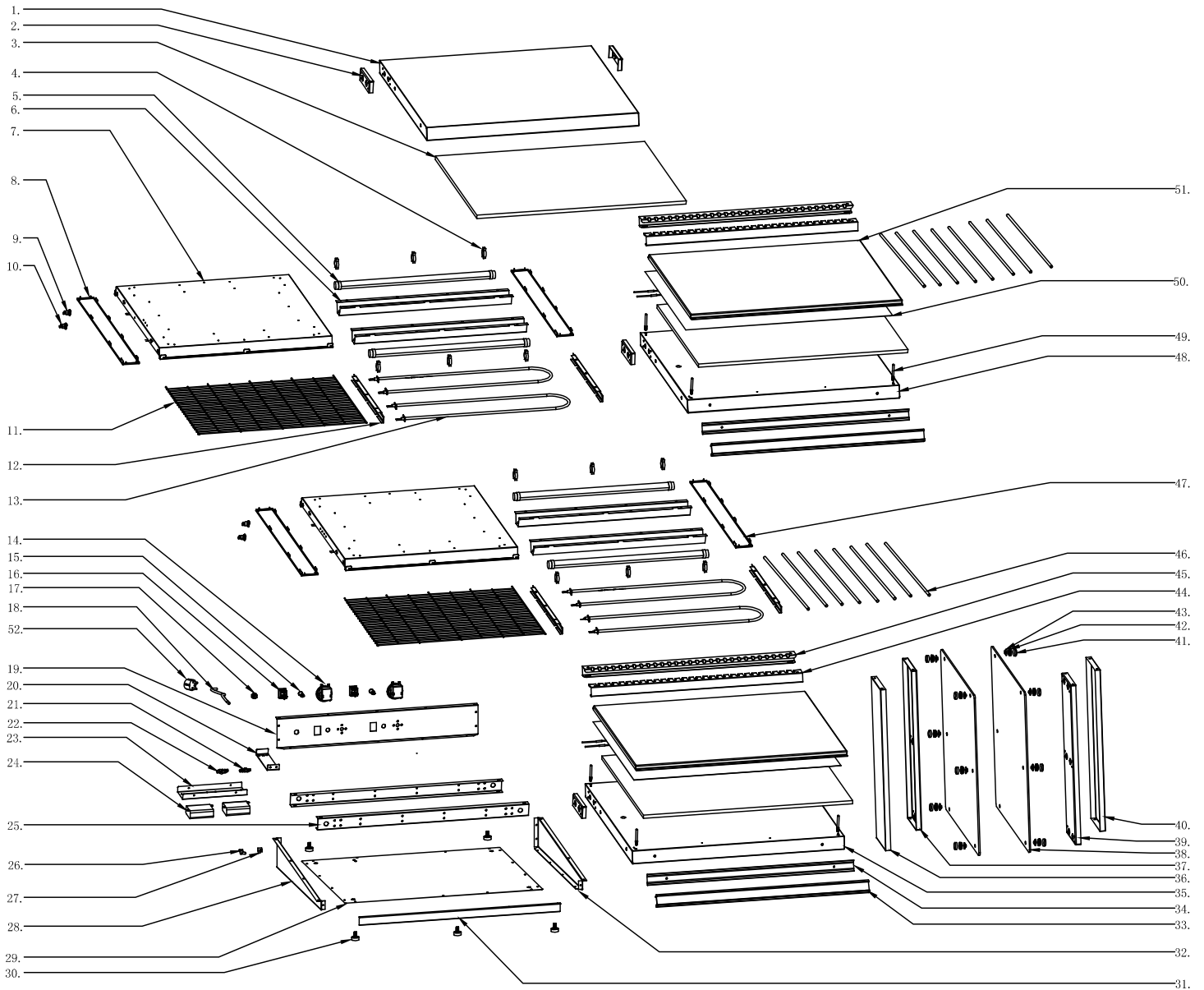



# Parts Breakdown

## Model DW-CN-0121 47512

Item No.	Description	Position	Item No.	Description	Position	Item No.	Description	Position
AL038	Top Outer Frame for 47512	1	AL045	Back Frame for 47512	19	AL008	Left Inner Pole for 47512	37
60492	Inner Reinforcing Plate for 47512	2	AK997	Cable Clip Fixer for 47512	20	60487	Side Glass for 47512	38
AL039	Insulation for 47512	3	61246	Wire Clip Holder for 47512	21	AL009	Right Inner Pole for 47512	39
AL078	Light Supporting Bar for 47512	4	61245	Wire Clip Cover for 47512	22	AL010	Right Outer Pole for 47512	40
AL040	LED for 47512	5	AK998	LED Power Supporting Bar for 47512	23	60101	Decorating Gasket of Nut for 47512	41
AL041	Light Guard for 47512	6	AK999	LED Power for 47512	24	60102	Nut Decorating Parts for 47512	42
AL042	Heating Tube Supporting Bar for 47512	7	AL046	Inner Supporting Bar for 47512	25	60103	Big Gasket of Nut for 47512	43
AK991	Left Guard for 47512	8	AD870	Fixed Plate for 47512	26	AL052	Supporting Bar of Front Shelf for 47512	44
70862	Thermostat T1/33 for 47512	9	AD869	Steel Ingot for 47512	27	AL053	Supporting Bar of Back Shelf for 47512	45
70863	Thermostat T1M/33 for 47512	10	60488	Left Frame for 47512	28	AL013	Bar for 47512	46
AL043	Protect Nets for 47512	11	AL047	Baseboard for 47512	29	AL014	Right Guard for 47512	47
AK993	Heating Element Frame for 47512	12	AL002	Rubber Feet for 47512	30	AL054	Middle Outer Frame for 47512	48
AL044	Heating Element for 47512	13	AL048	Front Frame for 47512	31	60479	Bolt for 47512	49
71640	Temperature Thermostat for 47512	14	60514	Right Frame for 47512	32	AL055	Aluminum Foil Heater for 47512	50
60218	Indicator Light for 47512	15	AL049	Price Tag for 47512	33	AL056	Cover Plate for 47512	51
70688	Switch for 47512	16	AL050	Price Tag Guard for 47512	34	AL096	Plug 5-20P for 47512	52
60213	Double-Faced Protective Ring C12 for 47512	17	AL051	Bottom Outer Frame for 47512	35			
AK995	Power Line for 47512	18	AL007	Left Outer Pole for 47512	36			

# Parts Breakdown

Model DW-CN-0138 47513

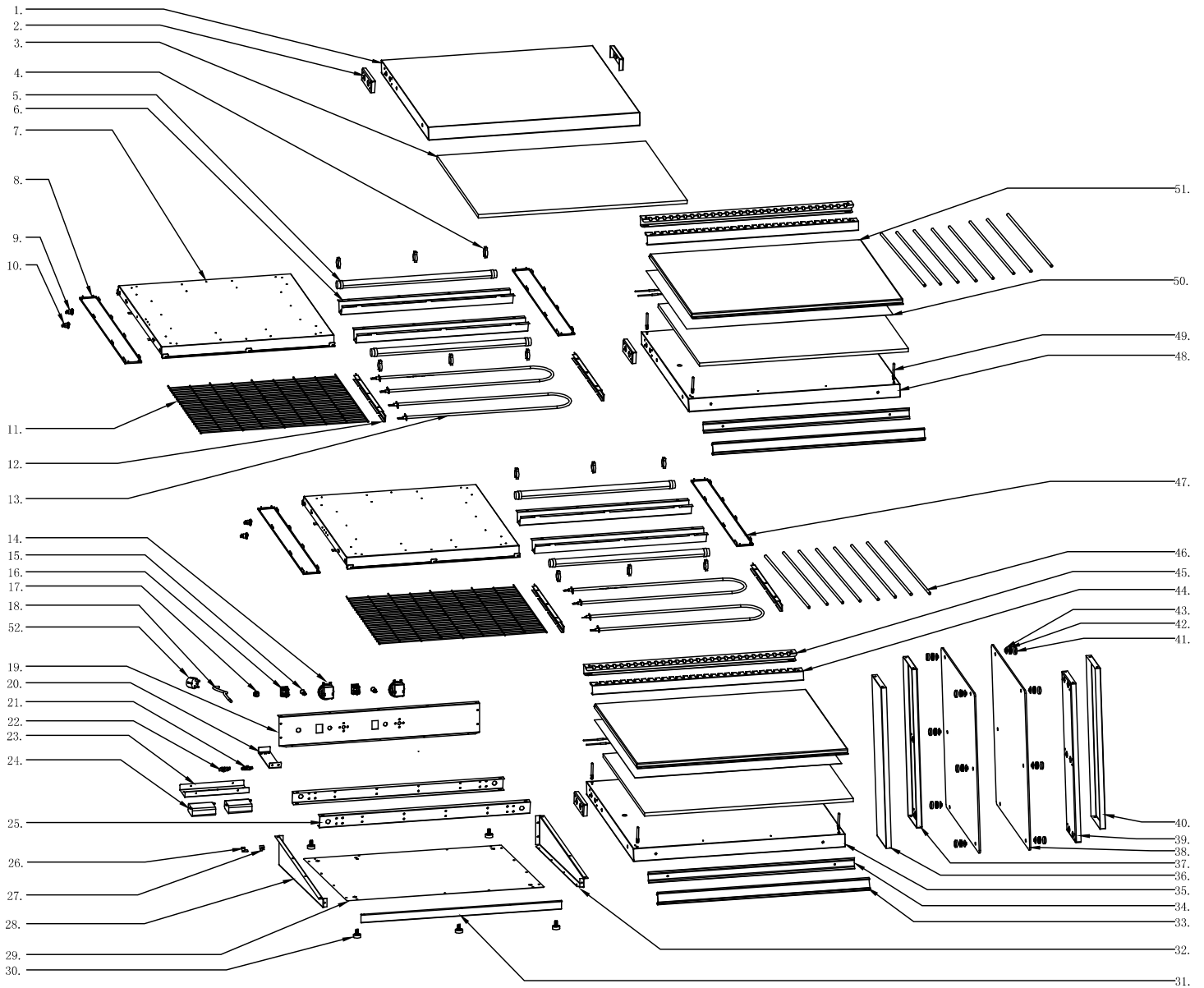





# Parts Breakdown

## Model DW-CN-0138 47513

Item No.	Description	Position	Item No.	Description	Position	Item No.	Description	Position
AL057	Top Outer Frame for 47513	1	AL064	Back Frame for 47513	19	AL008	Left Inner Pole for 47513	37
60492	Inner Reinforcing Plate for 47513	2	AK997	Cable Clip Fixer for 47513	20	60487	Side Glass for 47513	38
AL058	Insulation for 47513	3	61246	Wire Clip Holder for 47513	21	AL009	Right Inner Pole for 47513	39
AL078	Light Supporting Bar for 47513	4	61245	Wire Clip Cover for 47513	22	AL010	Right Outer Pole for 47513	40
AL059	LED for 47513	5	AK998	LED Power Supporting Bar for 47513	23	60101	Decorating Gasket of Nut for 47513	41
AL060	Light Guard for 47513	6	AK999	LED Power for 47513	24	60102	Nut Decorating Parts for 47513	42
AL061	Heating Tube Supporting Bar for 47513	7	AL065	Inner Supporting Bar for 47513	25	60103	Big Gasket of Nut for 47513	43
AK991	Left Guard for 47513	8	AD870	Fixed Plate for 47513	26	AL071	Supporting Bar of Front Shelf for 47513	44
70862	Thermostat T1/33 for 47513	9	AD869	Steel Ingot for 47513	27	AL072	Supporting Bar of Back Shelf for 47513	45
70863	Thermostat T1M/33 for 47513	10	60488	Left Frame for 47513	28	AL013	Bar for 47513	46
AL062	Protect Nets for 47513	11	AL066	Baseboard for 47513	29	AL014	Right Guard for 47513	47
AK993	Heating Element Frame for 47513	12	AL002	Rubber Feet for 47513	30	AL073	Middle Outer Frame for 47513	48
AL063	Heating Element for 47513	13	AL067	Front Frame for 47513	31	60479	Bolt for 47513	49
71640	Temperature Thermostat for 47513	14	60514	Right Frame for 47513	32	AL074	Aluminum Foil Heater for 47513	50
60218	Indicator Light for 47513	15	AL068	Price Tag for 47513	33	AL075	Cover Plate for 47513	51
70688	Switch for 47513	16	AL069	Price Tag Guard for 47513	34	AL096	Plug 5-20P for 47513	52
60213	Double-Faced Protective Ring C12 for 47513	17	AL070	Bottom Outer Frame for 47513	35			
AK995	Power Line for 47513	18	AL007	Left Outer Pole for 47513	36			

# Electrical Schematics

**Model DW-CN-0065** 47510

**Model DW-CN-0085** 43465

**Model DW-CN-0102** 47511

**Model DW-CN-0121** 47512

**Model DW-CN-0138** 47513

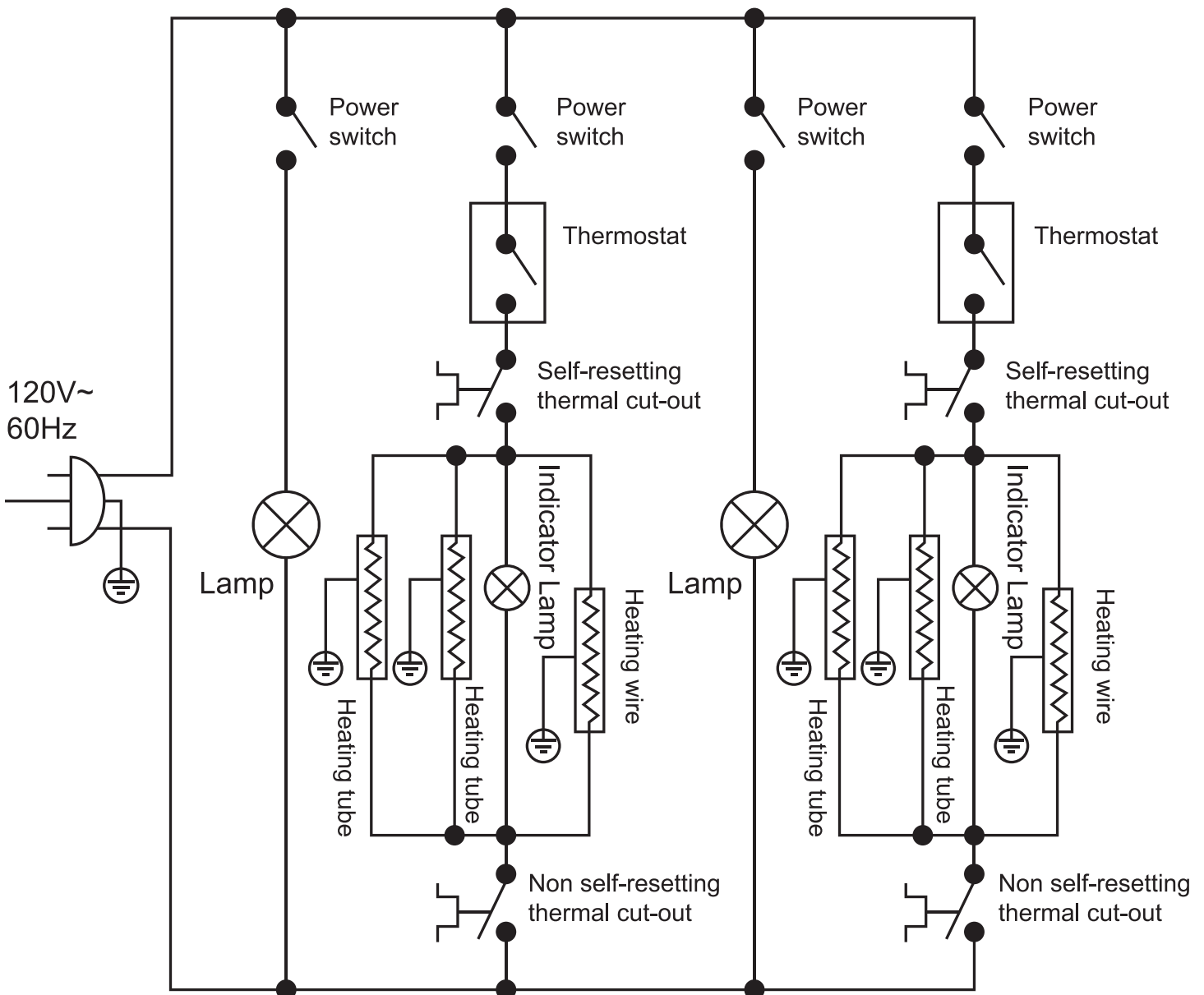



# Warranty Registration

Thank you for purchasing an Omcan product. To register your warranty for this product, complete the information below, tear off the card at the perforation and then send to the address specified below. You can also register online by visiting:

Merci d'avoir acheté un produit Omcan. Pour enregistrer votre garantie pour ce produit, complétez les informations ci-dessous, détachez la carte au niveau de la perforation, puis l'envoyer à l'adresse spécifiée ci-dessous. Vous pouvez également vous inscrire en ligne en visitant:

Gracias por comprar un producto Omcan usted. Para registrar su garantía para este producto, complete la información a continuación, cortar la tarjeta en la perforación y luego enviarlo a la dirección indicada a continuación. También puede registrarse en línea en:

<https://omcan.com/warranty-registration/>

For mailing in Canada

Pour postale au Canada

Por correo en Canadá

**OMCAN**

PRODUCT WARRANTY REGISTRATION

3115 Pepper Mill Court,

Mississauga, Ontario

Canada, L5L 4X5

For mailing in the US

Pour diffusion aux États-Unis

Por correo en los EE.UU.

**OMCAN**

PRODUCT WARRANTY REGISTRATION

4450 Witmer Industrial Estates, Unit 4,

Niagara Falls, New York

USA, 14305

*or email to: [service@omcan.com](mailto:service@omcan.com)*



Purchaser's Information

Name: \_\_\_\_\_

Address: \_\_\_\_\_

City: \_\_\_\_\_ Province or State: \_\_\_\_\_ Postal or Zip: \_\_\_\_\_

Country: \_\_\_\_\_

Dealer from which Purchased: \_\_\_\_\_

Dealer City: \_\_\_\_\_ Dealer Province or State: \_\_\_\_\_

Invoice: \_\_\_\_\_

Model Name: \_\_\_\_\_ Model Number: \_\_\_\_\_

Machine Description: \_\_\_\_\_

Date of Purchase (MM/DD/YYYY): \_\_\_\_\_

Would you like to extend the warranty?  Yes  No

Company Name: \_\_\_\_\_

Telephone: \_\_\_\_\_

Email Address: \_\_\_\_\_

Type of Company:

Restaurant  Bakery  Deli

Butcher  Supermarket  Caterer

Institution (specify): \_\_\_\_\_

Other (specify): \_\_\_\_\_

Serial Number: \_\_\_\_\_

Date of Installation (MM/DD/YYYY): \_\_\_\_\_

**Thank you for choosing Omcan | Merci d'avoir choisi Omcan | Gracias por elegir Omcan**



Since 1951 Omcan has grown to become a leading distributor of equipment and supplies to the North American food service industry. Our success over these many years can be attributed to our commitment to strengthen and develop new and existing relationships with our valued customers and manufacturers. Today with partners in North America, Europe, Asia and South America, we continually work to improve and grow the company. We strive to offer customers exceptional value through our qualified local sales and service representatives who provide convenient access to over 6,500 globally sourced products.

---

Depuis 1951 Omcan a grandi pour devenir un des “leaders” de la distribution des équipements et matériel pour l’industrie des services alimentaires en Amérique du Nord. Notre succès au cours de ces nombreuses années peut être attribué à notre engagement à renforcer et à développer de nouvelles et existantes relations avec nos clients et les fabricants de valeur. Aujourd’hui avec des partenaires en Amérique du Nord, Europe, Asie et Amérique du Sud, nous travaillons continuellement à améliorer et développer l’entreprise. Nous nous efforçons d’offrir à nos clients une valeur exceptionnelle grâce à nos ventes locales qualifiées et des représentants de service qui offrent un accès facile à plus de 6500 produits provenant du monde entier.

---

Desde 1951 Omcan ha crecido hasta convertirse en un líder en la distribución de equipos y suministros de alimentos en América del Norte industria de servicios. Nuestro éxito en estos años se puede atribuir a nuestro compromiso de fortalecer y desarrollar nuevas relaciones existentes con nuestros valiosos clientes y fabricantes. Hoy con socios de América del Norte, Europa, Asia y América del Sur, que trabajan continuamente para mejorar y crecer la empresa. Nos esforzamos por ofrecer a nuestros clientes valor excepcional a través de nuestro local de ventas y representantes de los servicios que proporcionan un fácil acceso a más de 6,500 productos con origen a nivel mundial.

